

Varenummer: 01010721
 Beskrivelse: Seeger låsering A 55 DIN 471
 Rustfast 411
 Note: Monteres med ZGA tang

Mål

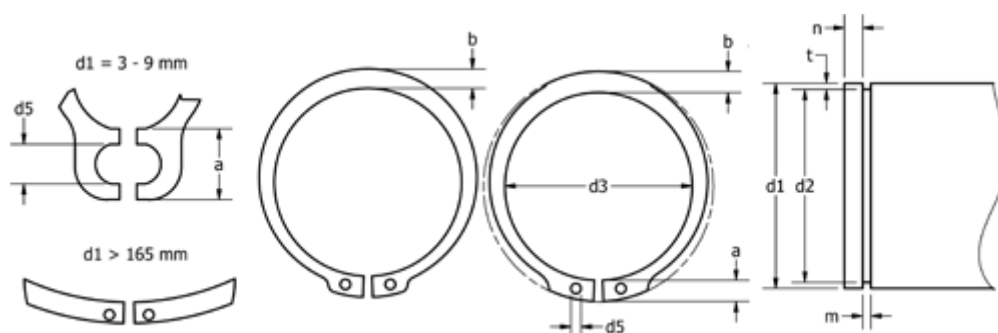

a max	= 7,2	FN kN	= 4.2	s	= 2.00
AN mm ²	= 252.0	FRg kN	= 11.40	t	= 1.50
b	= 5.4	FR kN	= 71.40	Tang	= ZGA-3
Betegnelse	= A55	g	= 2.5	tol	= -0.07
d1	= 55	K kN-mm	= 230.00	tol	= +0,46-1,10
d2	= 52.0	m min	= 2.15	tol	= -0.30
d3	= 50.8	n abl x 1000	= 9.0	vægt kg/1000	= 11.400
d5 min	= 2.5	Nominel træk	= 4.5		